

Algemene informatie

EasyAir Ventilatiebocht EPP 150 90°

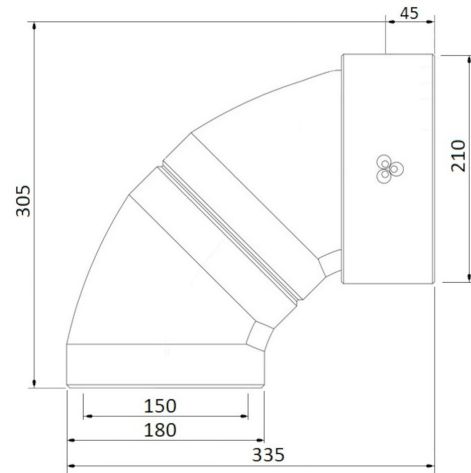

Specificaties

Artikelnummer	400480474
Producttype	Geïsoleerd kanaal
Hoofdmateriaal	EPP
Kleur	Grijs
Wanddikte luchttoevoerbuis (mm)	15
Netto gewicht (kg)	0,17

Afmetingen

Dn inwendig (mm)	150
Dn uitwendig (mm)	180
Afmetingen (l x b x h mm)	305 x 210 x 335

Toepassing

Beoogde toepassing	Ventilatie
Toevoer / afvoer	Toevoer/afvoer
Temperatuurbereik (°C)	-25 / +80

Technische specificaties

Maximale luchtstroom (m ³ /h)	375
ζ afvoer	0,20
ζ toevoer	0,20
Luchtdichtheidsklasse	3
λ Thermische geleidbaarheid (W/(m·K))	0,037
R-waarde (m ² K/W)	0,41
Brandklasse	E
Overige specificaties	-

Grafiek

Pressure loss

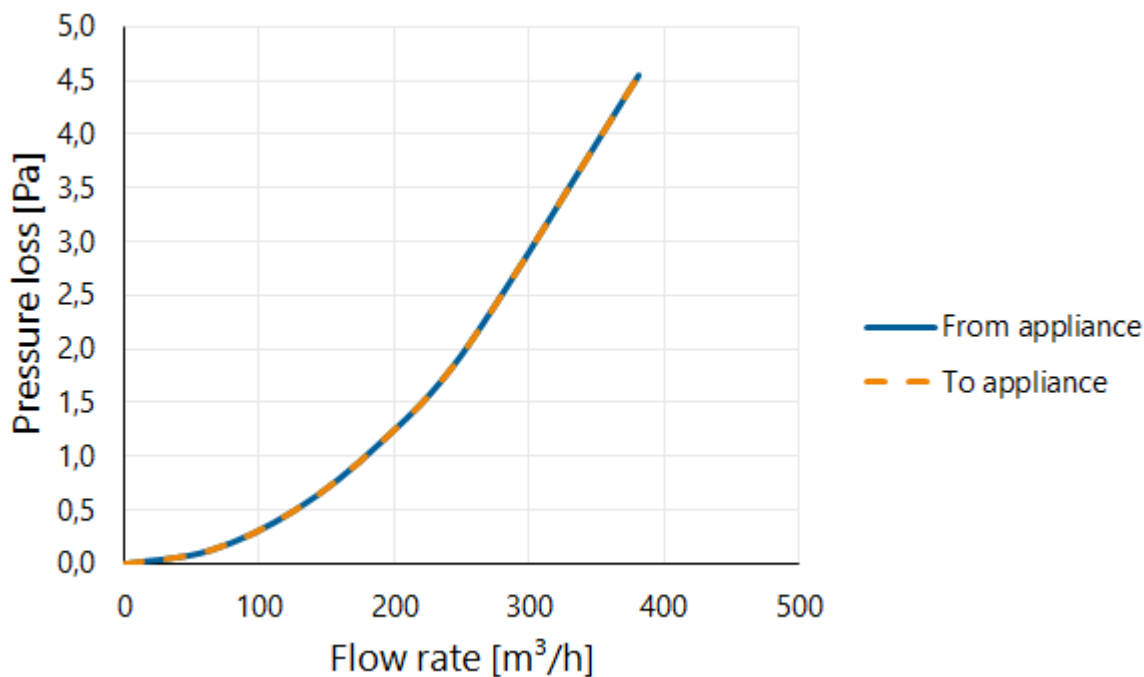

Tabel

Flow velocity pressure table

Flow rate			Static pressure loss	
[m/s]	[m³/h]	[l/s]	From appliance [Pa]	To appliance [Pa]
0	0	0	0,0	0,0
1	64	18	0,1	0,1
2	127	35	0,5	0,5
3	191	53	1,1	1,1
4	254	71	2,0	2,0
6	382	106	4,5	4,5