

Algemene informatie

EasyAir Ventilatiebocht EPS 160 45°

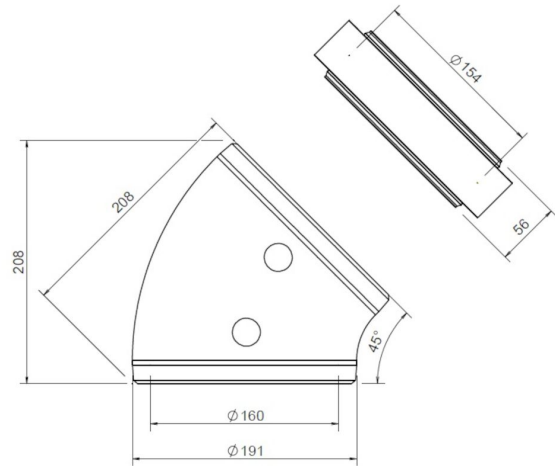

Specificaties

Artikelnummer	400480562
Producttype	Geïsoleerd kanaal
Hoofdmateriaal	EPS
Kleur	Grijs
Wanddikte luchttoevoerbuis (mm)	15,5
Netto gewicht (kg)	0,18

Afmetingen

Dn inwendig (mm)	160
Dn uitwendig (mm)	191
Afmetingen (l x b x h mm)	218 x 191 x 208

Toepassing

Beoogde toepassing	Ventilatie
Toevoer / afvoer	Toevoer/afvoer
Temperatuurbereik (°C)	-25 / +80

Technische specificaties

Maximale luchtstroom (m ³ /h)	425
ζ afvoer	0,16
ζ toevoer	0,16
Luchtdichtheidsklasse	2
λ Thermische geleidbaarheid (W/(m·K))	0,032
R-waarde (m ² K/W)	0,48
Brandklasse	E
Overige specificaties	-

Grafiek

Pressure loss

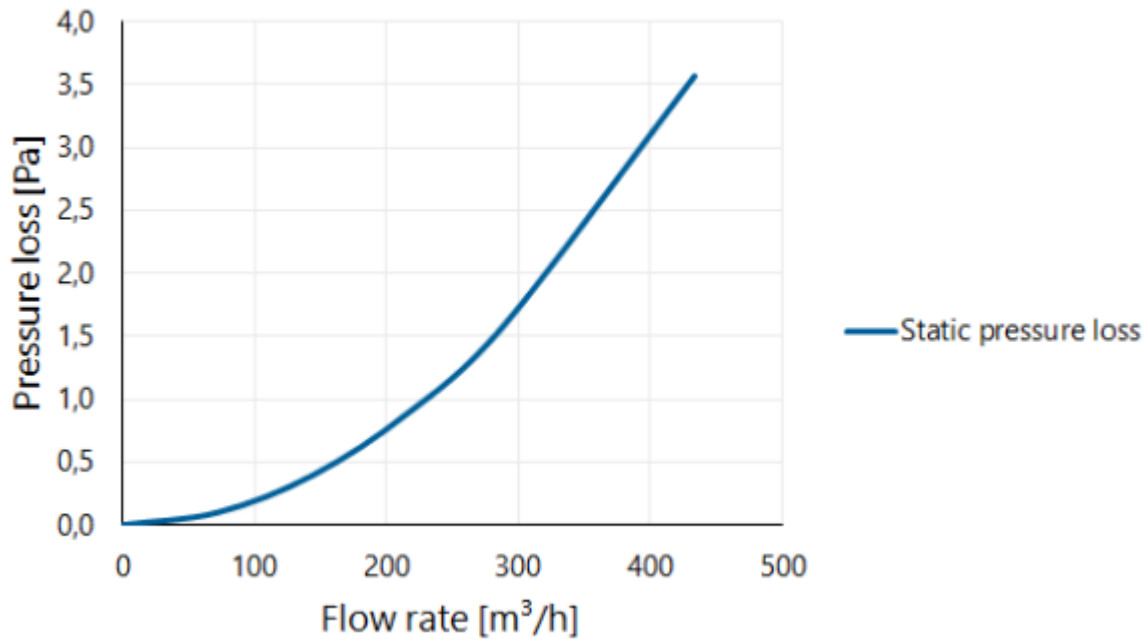

Tabel

Flow velocity pressure table

Flow rate			Static pressure loss [Pa]
[m/s]	[m³/h]	[l/s]	
0	0	0	0,0
1	72	20	0,1
2	145	40	0,4
3	217	60	0,9
4	290	80	1,6
6	434	121	3,6