

General information

Twinline Condensate trap horizontal/vertical PP 60

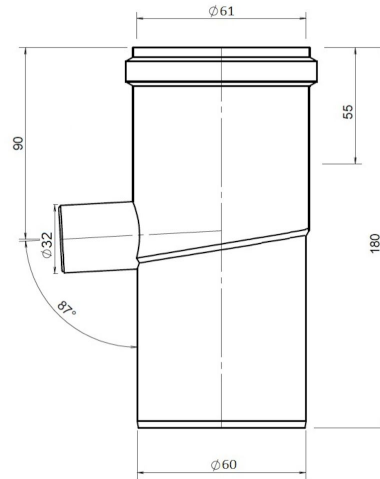

Specifications

Article number	400470220
Material flue duct	Plastic
Quality class flue duct	PP
Wall thickness flue duct nom (mm)	2,1
Material seal flue duct	EPDM
Colour	Gray (RAL 7040)
Weight (kg)	0,1

Dimensions

Diameter flue duct nom (mm)	60
Outer dimensions (l x w x h mm)	180 x 105 x 70

Application Insights

Intended use	Discharge of flue gases
Location class	For indoor use only

Technical Specifications

Declaration of performance	001-MG-PP DoP
Harmonized standard	EN 14471: 2013 + A1: 2015
System according to DoP	0.1
CE Marking	T120 H1 W2 O30 LI E U
ζF Flue duct	0,9
Thermal resistance flue duct (m ² K/W)	0
Roughness value flue duct (m)	0,001
Equivalent length (m)	1,5
Other specifications	-

Mounting and installation

Always install according to the national regulations. For safe installation, consult the installation and associated mounting instructions, see Burgerhout.com.

Graph

Pressure loss versus flow rate

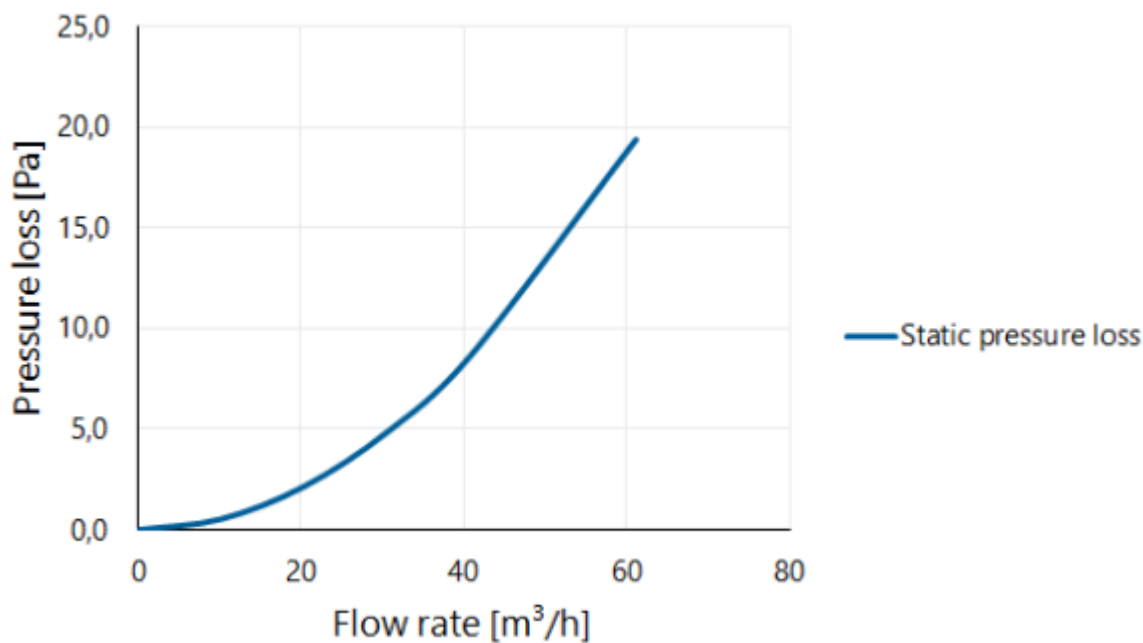

Table

Flow rate versus pressure loss

Flow rate			Static pressure loss [Pa]
[m/s]	[m³/h]	[l/s]	
0	0	0	0,0
1	10	3	0,5
2	20	6	2,2
3	31	8	4,9
4	41	11	8,6
6	61	17	19,4