

General information

Vent-Alu 2000 Ventilation Double wall with AL Cap 200

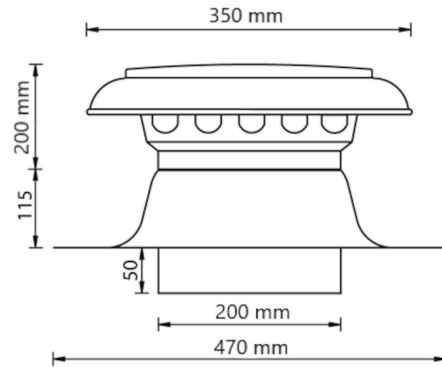

Specifications

Article Number	420455120
Product category	Roof vent
Material hood	Aluminium
Roof flashing material	Aluminum
Material isolation	PUR foam
Colour	Material own colour
Weight (kg)	1,35
Type	Double Walled

Dimensions

Application	Air
Roof slope (°)	-
Connection diameter	200
Dimensions (l x w x h mm)	470 x 470 x 365

Technical Specifications

Maximum air flow	679
Maximum air speed	6
Other specifications	-

Certifications

Documents	-
-----------	---

Differential pressure as a function of the volume flow measured according to NEN-EN 13141-5

Pressure loss

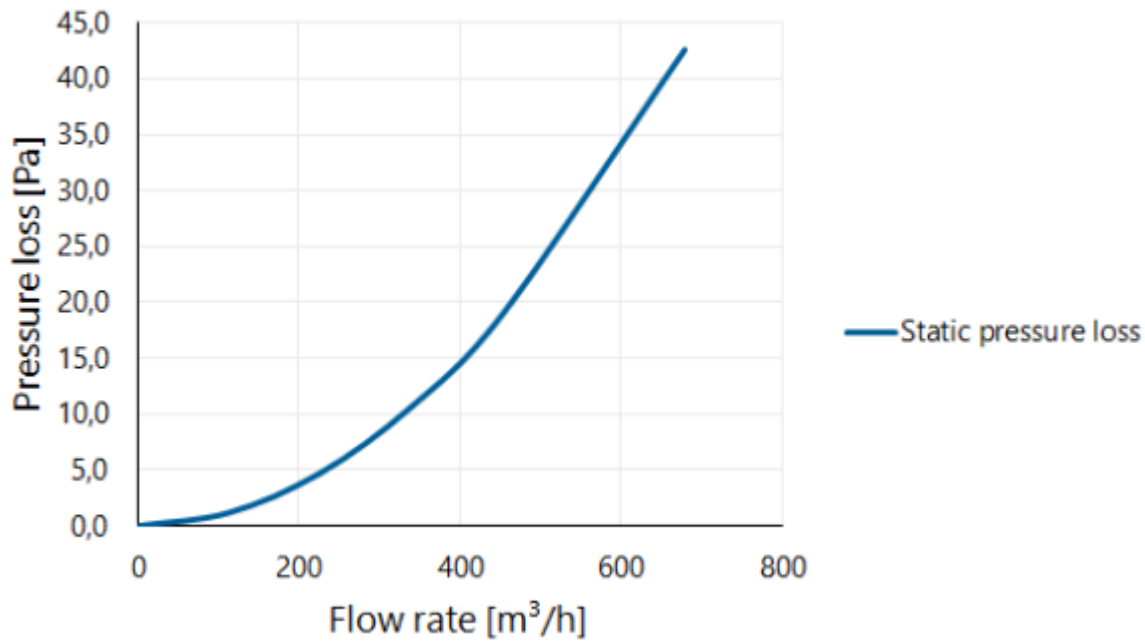

Differential pressure as a function of the speed and volume flow measured according to NEN-EN 13141-5

Flow velocity pressure table

Flow rate			Static pressure loss [Pa]
[m/s]	[m³/h]	[l/s]	
0	0	0	0,0
1	113	31	1,2
2	226	63	4,7
3	339	94	10,6
4	452	126	18,9
6	679	188	42,6