

General information

Vent-Alu 2000 Ventilation Double wall with AL Cap 315

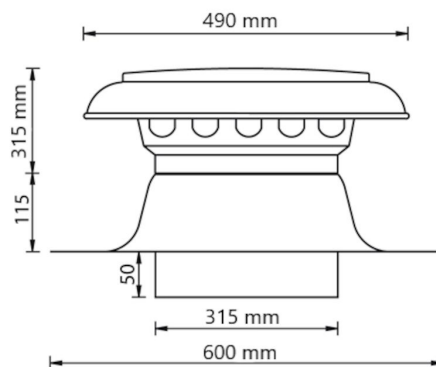

Specifications

Article Number	420455131
Product category	Roof vent
Material hood	Aluminium
Roof flashing material	Aluminum
Material isolation	PUR foam
Colour	Material own colour
Weight (kg)	2,72
Type	Double Walled

Dimensions

Application	Air
Roof slope (°)	-
Connection diameter	315
Dimensions (l x w x h mm)	600 x 600 x 480

Technical Specifications

Maximum air flow	1683
Maximum air speed	6
Other specifications	-

Certifications

Documents	-
-----------	---

Differential pressure as a function of the volume flow measured according to NEN-EN 13141-5

Pressure loss

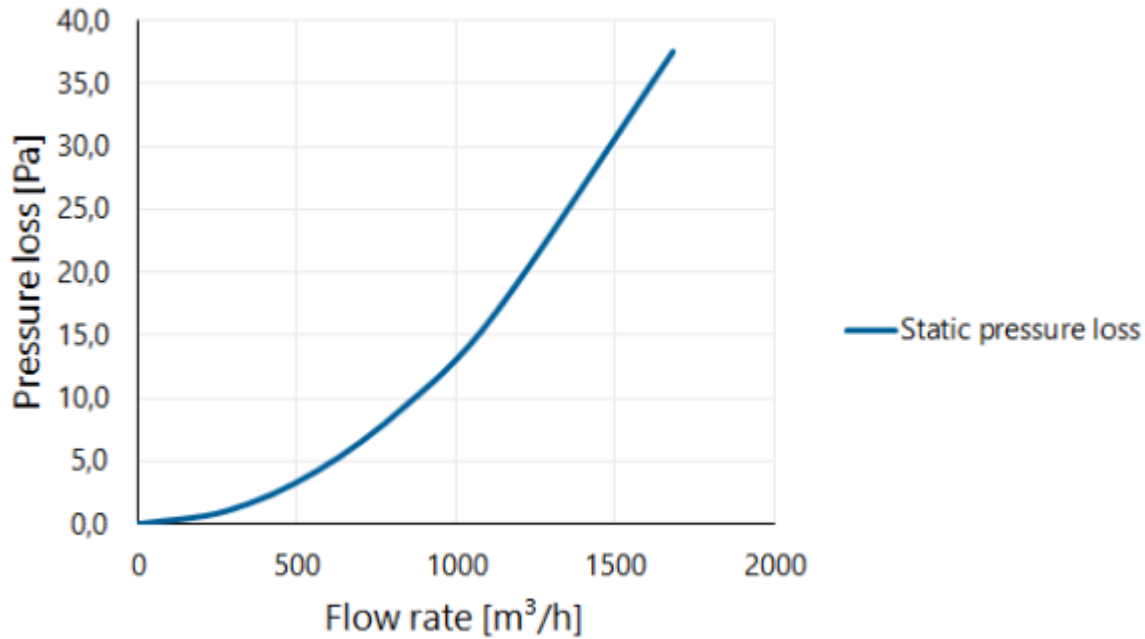

Differential pressure as a function of the speed and volume flow measured according to NEN-EN 13141-5

Flow velocity pressure table

Flow rate			Static pressure loss [Pa]
[m/s]	[m³/h]	[l/s]	
0	0	0	0,0
1	281	78	1,0
2	561	156	4,2
3	842	234	9,4
4	1122	312	16,7
6	1683	468	37,6