

General information

Vent-Alu 2000 Ventilation Double wall with PP Cap 250

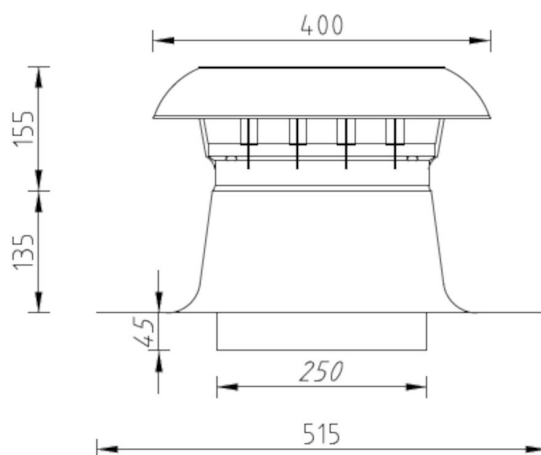

Specifications

Article Number	420459125
Product category	Roof vent
Material hood	PP
Roof flashing material	Aluminum
Material isolation	PUR foam
Colour	Black
Weight (kg)	1,72
Type	Double Walled

Dimensions

Application	Air
Roof slope (°)	-
Connection diameter	200
Dimensions (l x w x h mm)	515 x 515 x 335

Technical Specifications

Maximum air flow	1060
Maximum air speed	6
Other specifications	-

Certifications

Documents	-
-----------	---

Differential pressure as a function of the volume flow measured according to NEN-EN 13141-5

Pressure loss

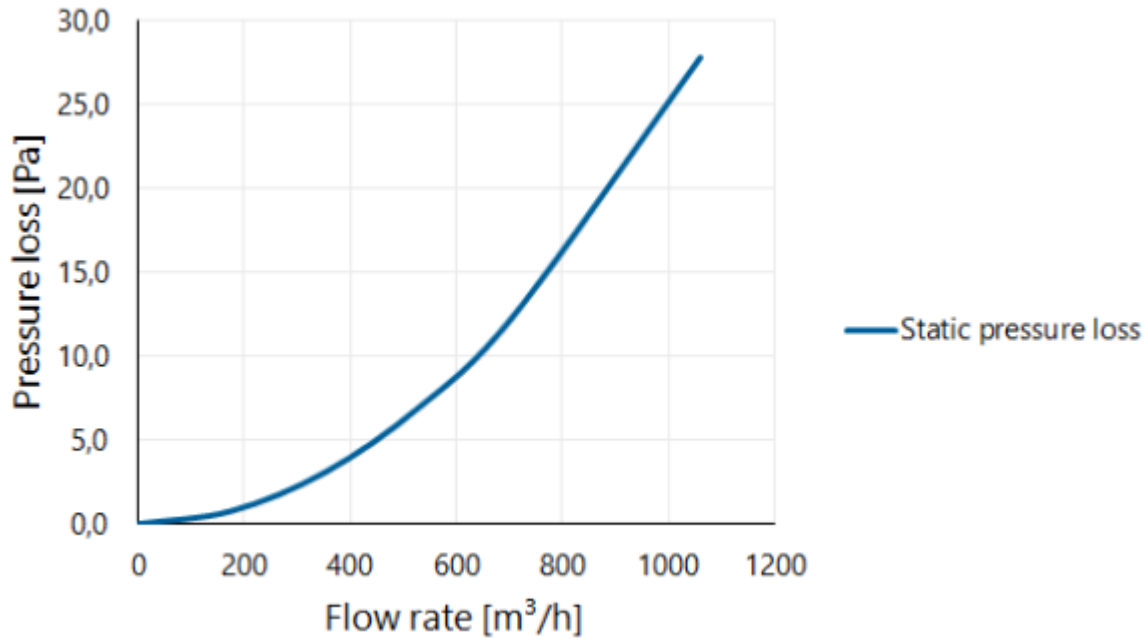

Differential pressure as a function of the speed and volume flow measured according to NEN-EN 13141-5

Flow velocity pressure table

Flow rate			Static pressure loss [Pa]
[m/s]	[m³/h]	[l/s]	
0	0	0	0,0
1	177	49	0,8
2	353	98	3,1
3	530	147	6,9
4	707	196	12,4
6	1060	295	27,8