

## General information

Vent-Alu 2000 Ventilation Single wall with AL Cap 200 and PVC coating

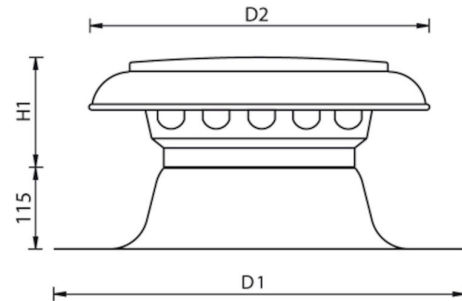

## Specifications

Article Number	420475020
Product category	Roof vent
Material hood	Aluminium
Roof flashing material	Aluminium with PVC
Material isolation	-
Colour	Material own colour
Weight (kg)	0,93
Type	Single Walled

## Dimensions

Application	Air
Roof slope (°)	-
Connection diameter	200
Dimensions (l x w x h mm)	470 x 470 x 315

## Technical Specifications

Maximum air flow	679
Maximum air speed	6
Other specifications	-

## Certifications

Documents	-
-----------	---

## Differential pressure as a function of the volume flow measured according to NEN-EN 13141-5

Pressure loss

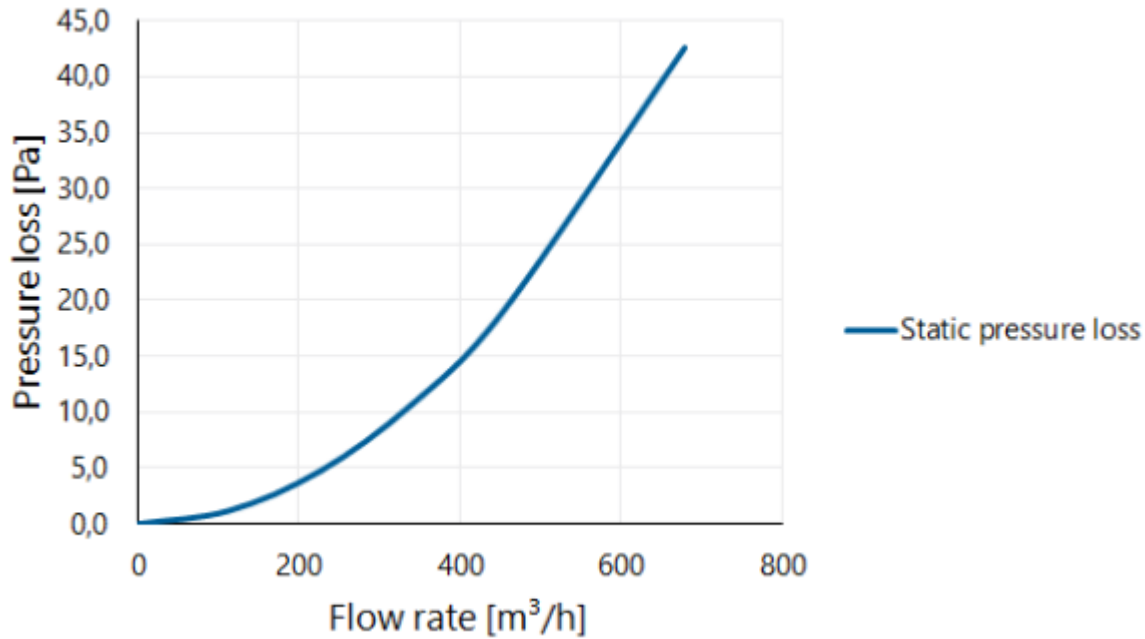

## Differential pressure as a function of the speed and volume flow measured according to NEN-EN 13141-5

Flow velocity pressure table

Flow rate			Static pressure loss [Pa]
[m/s]	[m³/h]	[l/s]	
0	0	0	0,0
1	113	31	1,2
2	226	63	4,7
3	339	94	10,6
4	452	126	18,9
6	679	188	42,6