

General information

Vent-Alu 2000 Ventilation Single wall with AL Cap 250

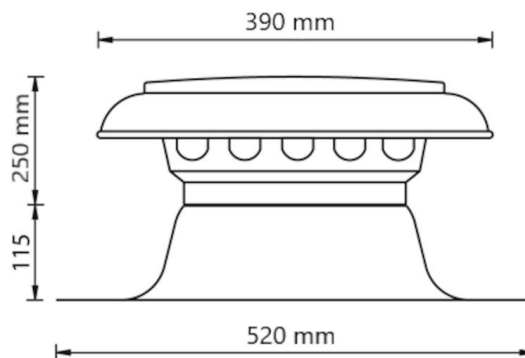

Specifications

Article Number	420455025
Product category	Roof vent
Material hood	Aluminium
Roof flashing material	Aluminum
Material isolation	-
Colour	Material own colour
Weight (kg)	1,38
Type	Single Walled

Dimensions

Application	Air
Roof slope (°)	-
Connection diameter	250
Dimensions (l x w x h mm)	520 x 520 x 365

Technical Specifications

Maximum air flow	1060
Maximum air speed	6
Other specifications	-

Certifications

Documents	-
-----------	---

Differential pressure as a function of the volume flow measured according to NEN-EN 13141-5

Pressure loss

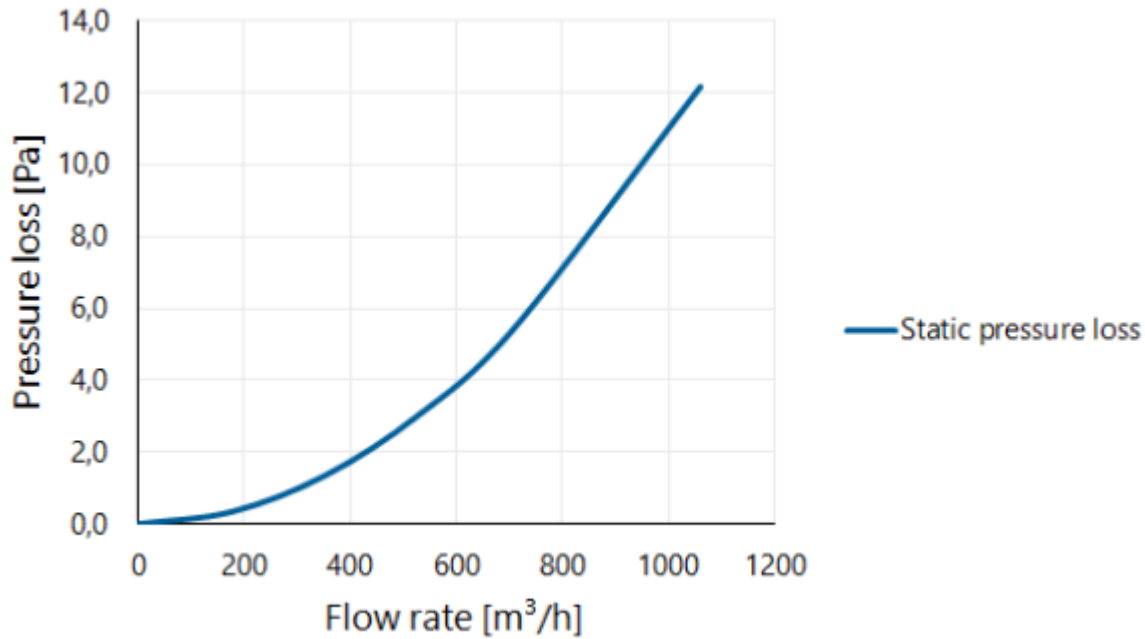

Differential pressure as a function of the speed and volume flow measured according to NEN-EN 13141-5

Flow velocity pressure table

Flow rate			Static pressure loss [Pa]
[m/s]	[m³/h]	[l/s]	
0	0	0	0,0
1	177	49	0,3
2	353	98	1,4
3	530	147	3,0
4	707	196	5,4
6	1060	295	12,2