

General information

Vent-Alu 2000 Ventilation Single wall with AL Cap 315 and PVC coating

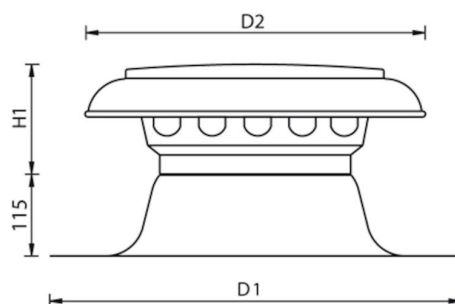

Specifications

Article Number	420475031
Product category	Roof vent
Material hood	Aluminium
Roof flashing material	Aluminium with PVC
Material isolation	-
Colour	Material own colour
Weight (kg)	2,11
Type	Single Walled

Dimensions

Application	Air
Roof slope (°)	-
Connection diameter	315
Dimensions (l x w x h mm)	600 x 600 x 430

Technical Specifications

Maximum air flow	1683
Maximum air speed	6
Other specifications	-

Certifications

Documents	-
-----------	---

Differential pressure as a function of the volume flow measured according to NEN-EN 13141-5

Pressure loss

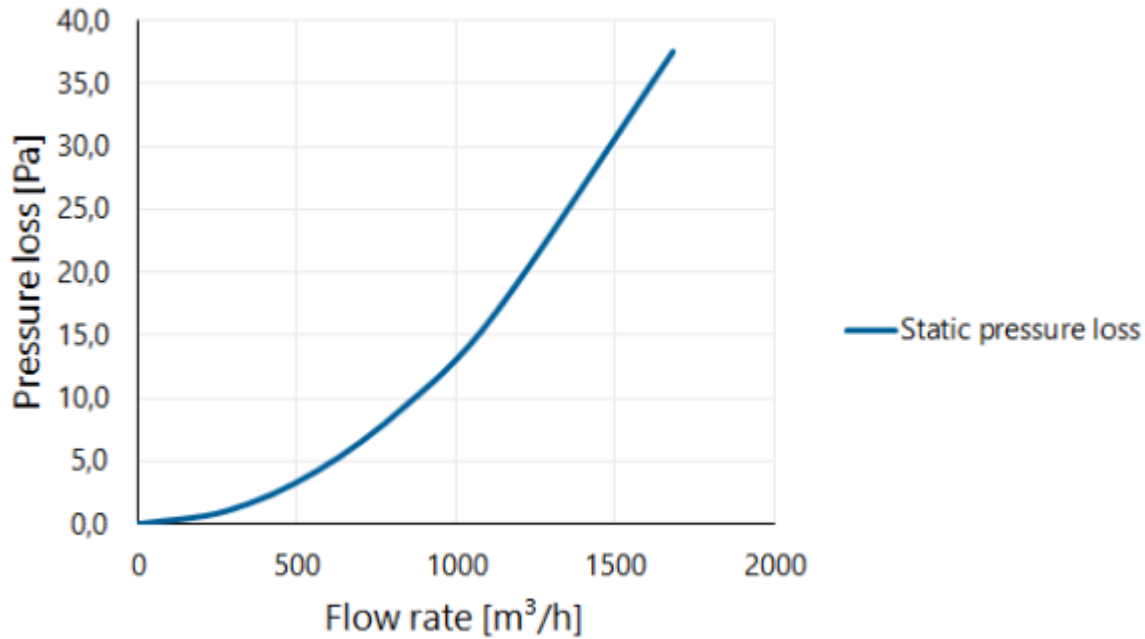

Differential pressure as a function of the speed and volume flow measured according to NEN-EN 13141-5

Flow velocity pressure table

Flow rate			Static pressure loss [Pa]
[m/s]	[m³/h]	[l/s]	
0	0	0	0,0
1	281	78	1,0
2	561	156	4,2
3	842	234	9,4
4	1122	312	16,7
6	1683	468	37,6