

General information

Vent-Alu 2000 Ventilation Single wall with AL Cap 315

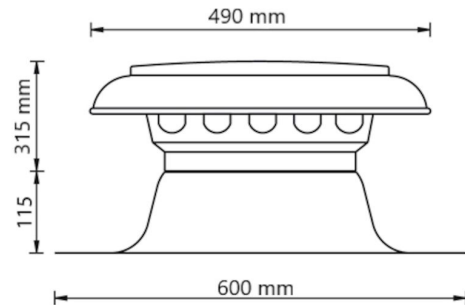

Specifications

Article Number	420455031
Product category	Roof vent
Material hood	Aluminium
Roof flashing material	Aluminum
Material isolation	-
Colour	Material own colour
Weight (kg)	2,11
Type	Single Walled

Dimensions

Application	Air
Roof slope (°)	-
Connection diameter	315
Dimensions (l x w x h mm)	600 x 600 x 430

Technical Specifications

Maximum air flow	1683
Maximum air speed	6
Other specifications	-

Certifications

Documents	-
-----------	---

Differential pressure as a function of the volume flow measured according to NEN-EN 13141-5

Pressure loss

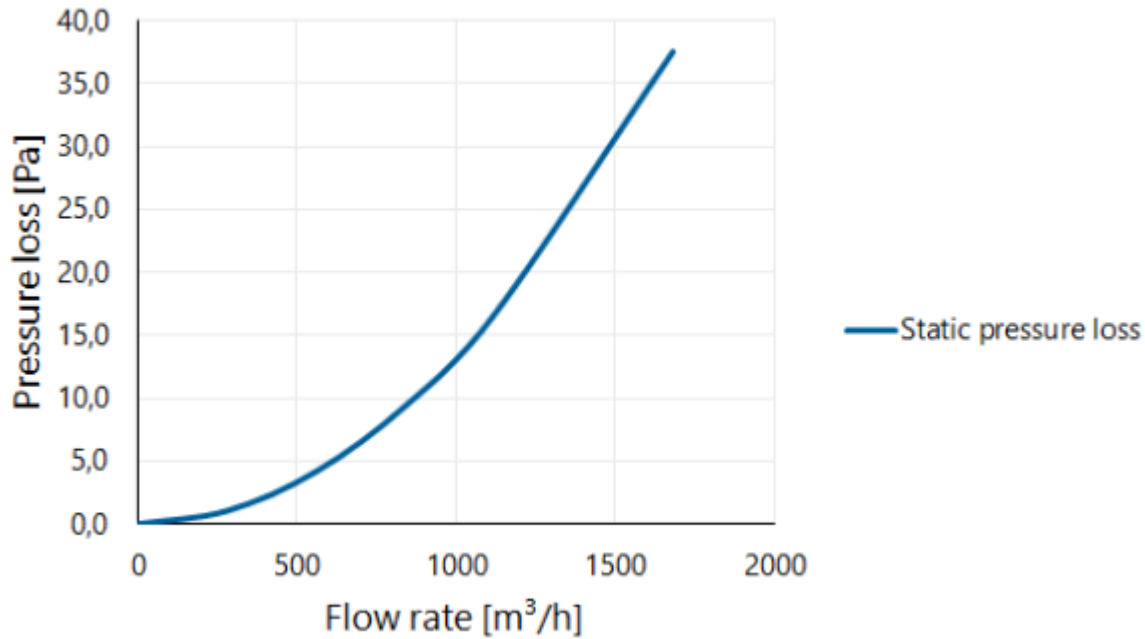

Differential pressure as a function of the speed and volume flow measured according to NEN-EN 13141-5

Flow velocity pressure table

Flow rate			Static pressure loss [Pa]
[m/s]	[m³/h]	[l/s]	
0	0	0	0,0
1	281	78	1,0
2	561	156	4,2
3	842	234	9,4
4	1122	312	16,7
6	1683	468	37,6