

General information

Vent-Alu 2000 Ventilation Single wall with AL Cap 350 and PVC coating

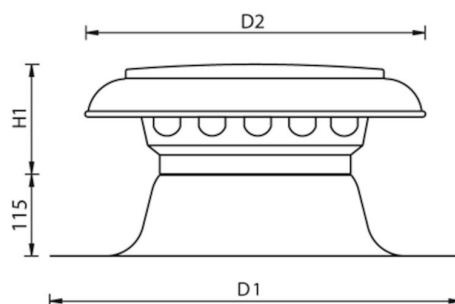

Specifications

Article Number	420475035
Product category	Roof vent
Material hood	Aluminium
Roof flashing material	Aluminium with PVC
Material isolation	-
Colour	Material own colour
Weight (kg)	2,53
Type	Single Walled

Dimensions

Application	Air
Roof slope (°)	-
Connection diameter	350
Dimensions (l x w x h mm)	620 x 620 x 465

Technical Specifications

Maximum air flow	2078
Maximum air speed	6
Other specifications	-

Certifications

Documents	-
-----------	---

Differential pressure as a function of the volume flow measured according to NEN-EN 13141-5

Pressure loss

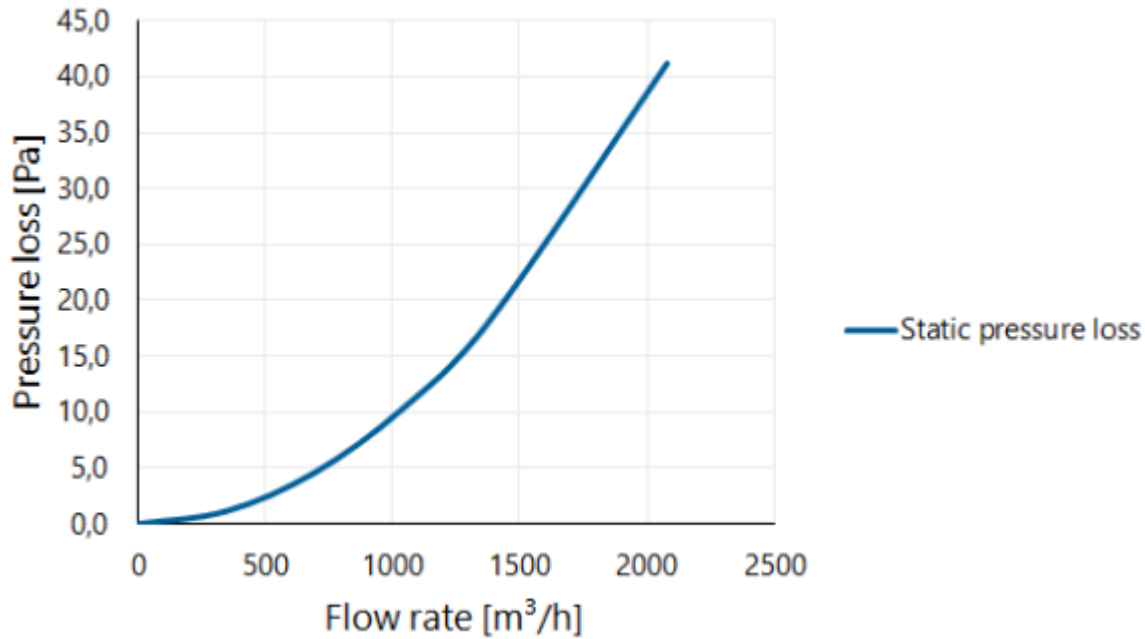

Differential pressure as a function of the speed and volume flow measured according to NEN-EN 13141-5

Flow velocity pressure table

Flow rate			Static pressure loss [Pa]
[m/s]	[m³/h]	[l/s]	
0	0	0	0,0
1	346	96	1,1
2	693	192	4,6
3	1039	289	10,3
4	1385	385	18,3
6	2078	577	41,1