

General information

Vent-Alu 2000 Ventilation Single wall with PP Cap 200 and PVC coating

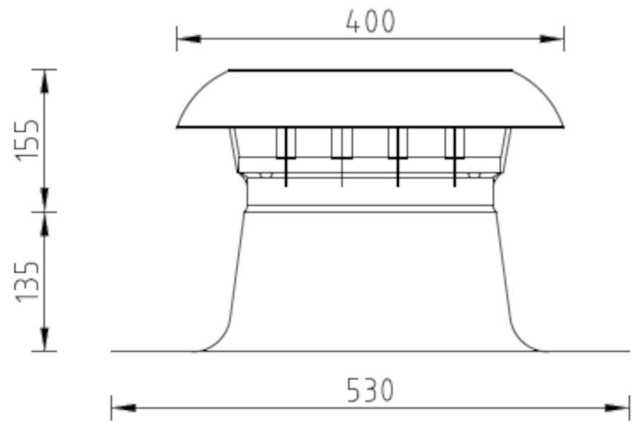

Specifications

Article Number	420479020
Product category	Roof vent
Material hood	PP
Roof flashing material	Aluminum
Material isolation	PUR foam
Colour	Black
Weight (kg)	1,26
Type	Single Walled

Dimensions

Application	Air
Roof slope (°)	-
Connection diameter	200
Dimensions (l x w x h mm)	530 x 530 x 290

Technical Specifications

Maximum air flow	679
Maximum air speed	6
Other specifications	-

Certifications

Documents	-
-----------	---

Differential pressure as a function of the volume flow measured according to NEN-EN 13141-5

Pressure loss

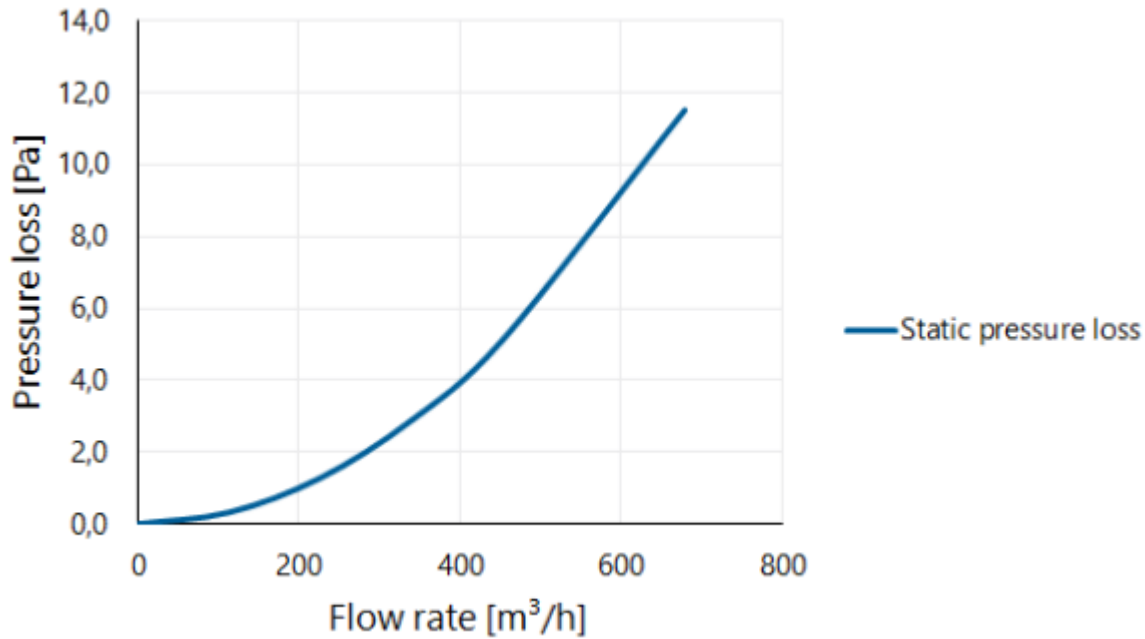

Differential pressure as a function of the speed and volume flow measured according to NEN-EN 13141-5

Flow velocity pressure table

Flow rate			Static pressure loss [Pa]
[m/s]	[m³/h]	[l/s]	
0	0	0	0,0
1	113	31	0,3
2	226	63	1,3
3	339	94	2,9
4	452	126	5,1
6	679	188	11,5