

General information

Alu-fix Elbow AL 80 90°

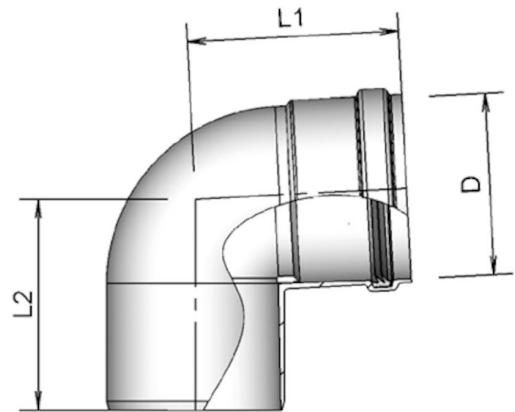

Specifications

Article number	400451552
Material flue duct	Aluminium
Quality class flue duct	EN 573-3: 2019; EN AW AISi12(A)
Wall thickness flue duct nom (mm)	1,5
Material seal flue duct	Silicone Blue
Colour	Material own colour
Weight (kg)	0,29

Dimensions

Diameter flue duct nom (mm)	80
Outer dimensions (l x w x h mm)	140 x 135 x 91

Application Insights

Intended use	Discharge of flue gases
Location class	For indoor use only

Technical Specifications

Declaration of performance	001-MG-ALU DoP
Harmonized standard	EN 1856-1: 2009
System according to DoP	0.1
CE Marking	T200 P1 W V1 L10/11/13 150 O30
ζF Flue duct	1,34
Thermal resistance flue duct (m ² K/W)	0
Roughness value flue duct (m)	N.a.
Equivalent length (m)	3,5
Other specifications	-

Mounting and installation

Always install according to the national regulations. For safe installation, consult the installation and associated mounting instructions, see Burgerhout.com.

Graph

Pressure loss versus flow rate

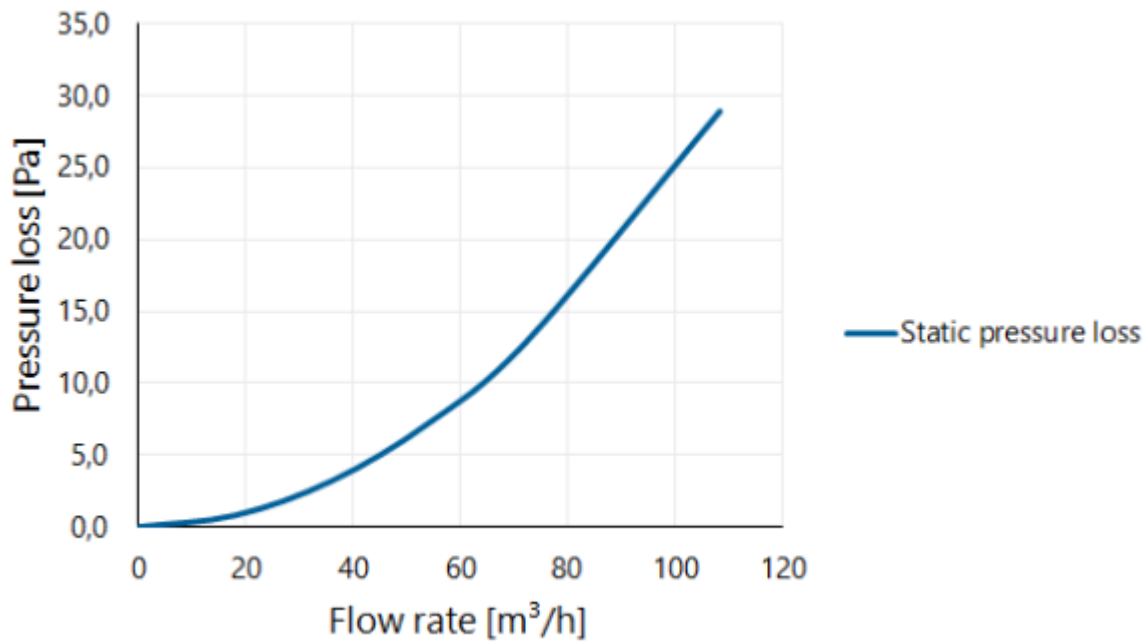

Table

Flow rate versus pressure loss

Flow rate			Static pressure loss [Pa]
[m/s]	[m³/h]	[l/s]	
0	0	0	0,0
1	18	5	0,8
2	36	10	3,2
3	54	15	7,2
4	72	20	12,9
6	109	30	28,9