

## General information

### EasyAir Elbow EPP 125 90°

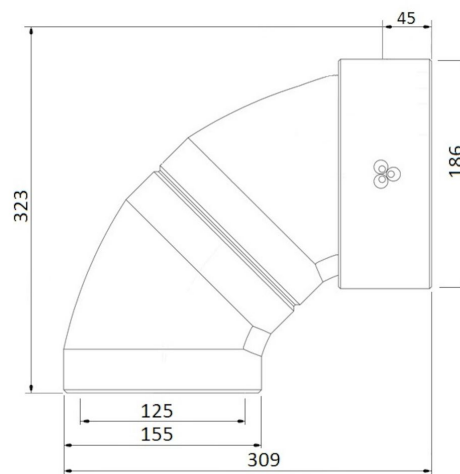

## Specifications

Article number	400480484
Product category	Insulated tube
Material	EPP
Colour	Gray
Wall Thickness (mm)	15
Weight (kg)	0,23

## Dimensions

Diameter inside (mm)	125
Diameter outside (mm)	155
Dimensions (l x w x h mm)	323 x 186 x 309

## Application Insights

Intended use	Ventilation
Supply / Extract	Supply/Extract
Temperature range (°C)	-25 / +80

## Technical Specifications

---

Maximum air flow (m <sup>3</sup> /h)	275
ζ extract	0,21
ζ supply	0,21
Air Tightness Class	3
λ Thermal conductivity (W/(m·K))	0,037
R-value (m <sup>2</sup> K/W)	0,41
Fire rating	E
Other specifications	-

## Graph

Pressure loss

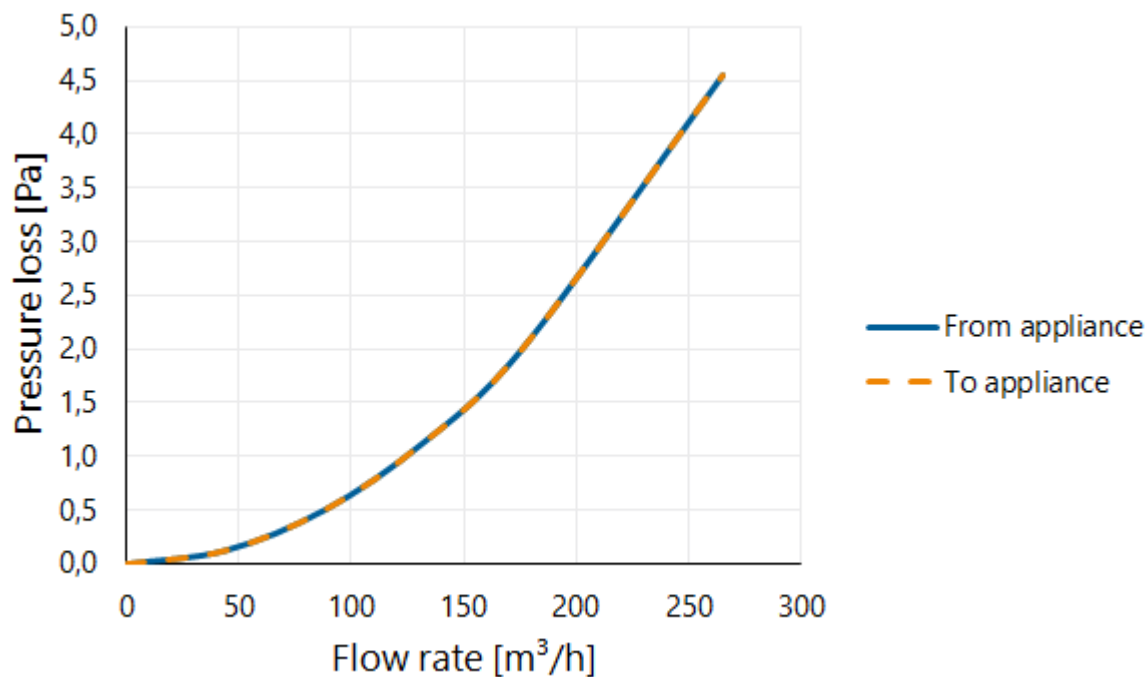

## Table

Flow velocity pressure table

Flow rate			Static pressure loss	
[m/s]	[m³/h]	[l/s]	From appliance [Pa]	To appliance [Pa]
0	0	0	0,0	0,0
1	44	12	0,1	0,1
2	88	25	0,5	0,5
3	133	37	1,1	1,1
4	177	49	2,0	2,0
6	265	74	4,5	4,5