

General information

EasyAir Elbow EPP 160 45°

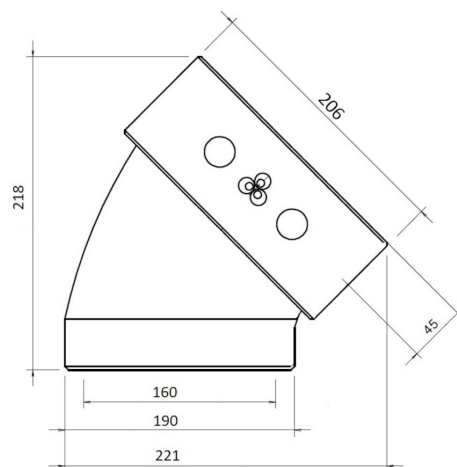

Specifications

Article number	400480496
Product category	Insulated tube
Material	EPP
Colour	Gray
Wall Thickness (mm)	15
Weight (kg)	0,16

Dimensions

Diameter inside (mm)	160
Diameter outside (mm)	190
Dimensions (l x w x h mm)	218 x 221 x 206

Application Insights

Intended use	Ventilation
Supply / Extract	Supply/Extract
Temperature range (°C)	-25 / +80

Technical Specifications

Maximum air flow (m ³ /h)	425
ζ extract	0,12
ζ supply	0,12
Air Tightness Class	3
λ Thermal conductivity (W/(m·K))	0,037
R-value (m ² K/W)	0,41
Fire rating	E
Other specifications	-

Graph

Pressure loss

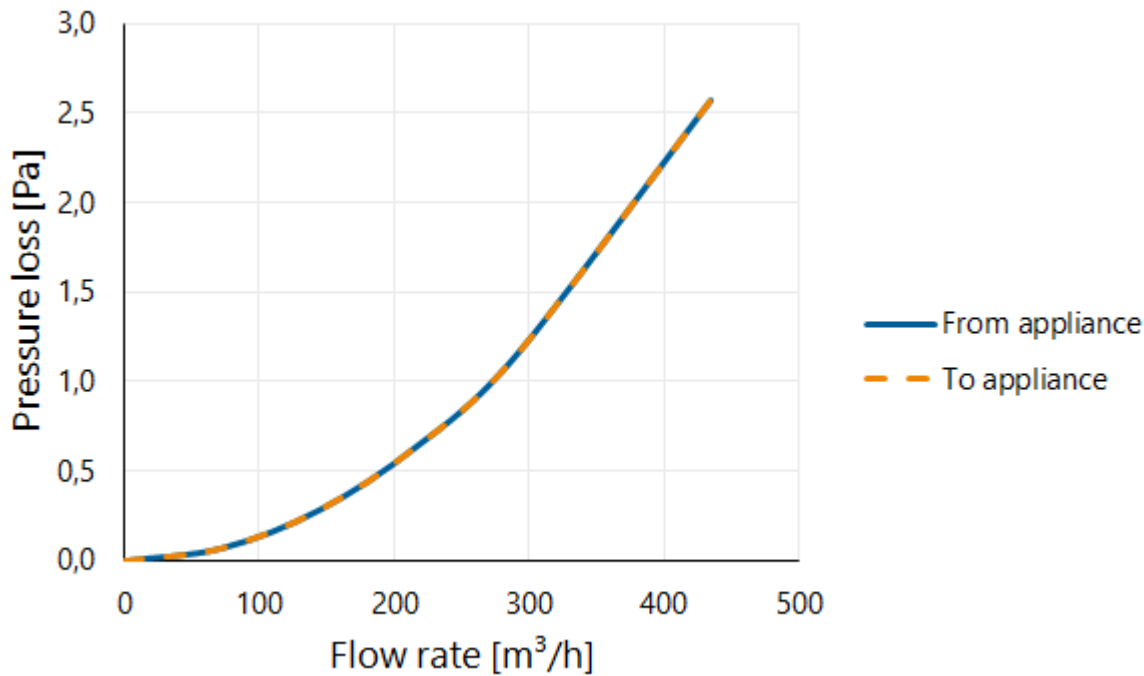

Table

Flow velocity pressure table

Flow rate			Static pressure loss	
[m/s]	[m³/h]	[l/s]	From appliance [Pa]	To appliance [Pa]
0	0	0	0,0	0,0
1	72	20	0,1	0,1
2	145	40	0,3	0,3
3	217	60	0,6	0,6
4	290	80	1,1	1,1
6	434	121	2,6	2,6